

# :glamour

M I R R O R S

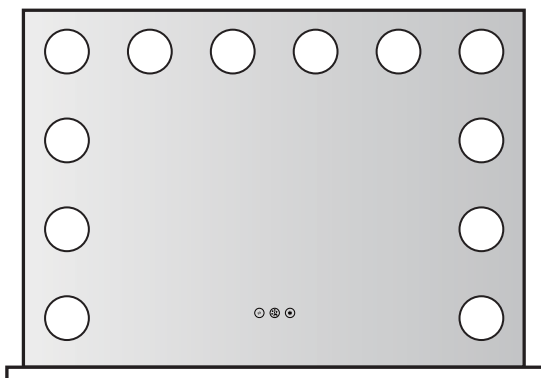

Marilyn  
400.08.04



Tap the button once to turn on the light





Tap the button once to change the light color



Hold the button to adjust the brightness



ITEMS INCLUDED	
	
UK 3-Pin	Screw Kit

ITEMS REQUIRED

Screw Driver

## STEP 1

Unpack the mirror carefully and lay on a flat soft surface.

## STEP 2

Align the holes in the base with the corresponding ones on the base of the mirror.

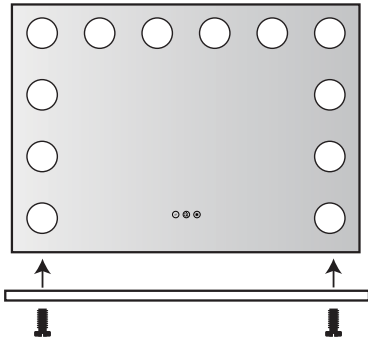

## STEP 3

Use the screwdriver to screw the bolts into the holes tightly.

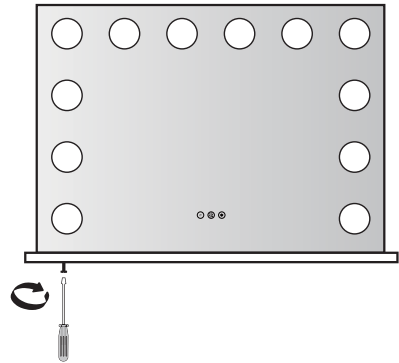

Underside of base

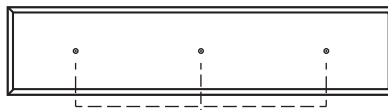

Screw locations

# WALL MOUNTING INSTRUCTIONS



## STEP 1

Unpack the mirror carefully and lay on a flat soft surface.

## STEP 2

Measure the distance between the keyholes on the rear of the mirror.

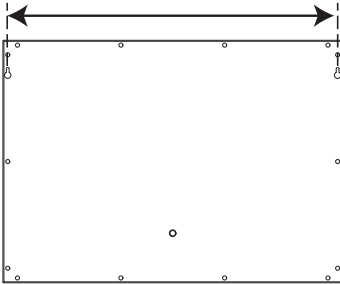

## STEP 3

Mark the slot locations directly on the wall for installation.

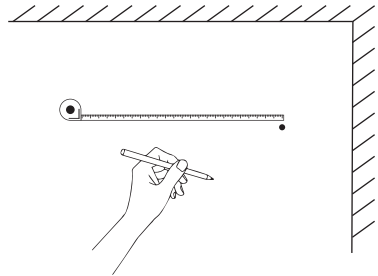

## STEP 4

Use a drill to drill the marked holes and insert the wall plugs and screws.

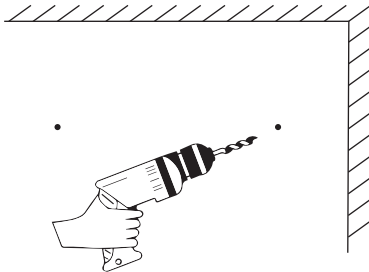

## STEP 5

Carefully hang the mirror on the wall by aligning the keyholes with the protruding screws.

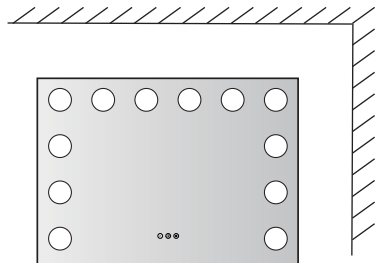

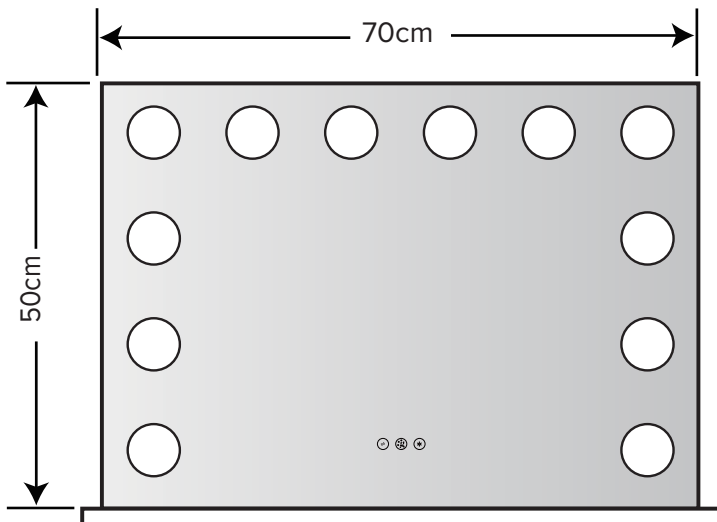

## TECHNICAL INFORMATION

**LED Colour:** 3000k-6000K

**Input:** 12V **Power:** 17.6W

**USB Output:** 5V = 1A

**Plug Type:** UK 3-Pin

**Material:** Iron+Glass

**Mirror HxWxD:** 50cm x 70cm x 3.8cm

**Base HxWxD:** 2.5cm x 75cm x 18cm

## WARNINGS

This is not a toy.

Not suitable for children under 3yrs.

Keep away from water.

Always unplug small appliances.

## ENERGY RATING

This product contains a light source of energy efficiency grade F.

The light source in this product may be damaged if it is removed. However, it can be replaced.

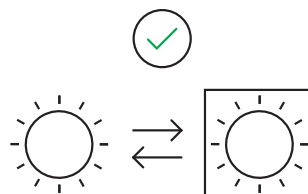



# IMPORTANT SAFETY INSTRUCTIONS

## THESE INSTRUCTIONS ARE PROVIDED FOR YOUR SAFETY

It is important that this product is used only for the intended purposes:

- Domestic use only
- LED Bulbs are embedded, non-adjustable and non-replaceable.
- When unpacking do not place upright on a hard surface until you have finished setting up the mirror.
- Always unplug from the power outlet when the product is not in use as even when plugged in the wires are still live.

## TO AVOID RISK OF FIRE, BURNS, PERSONAL INJURY AND ELECTRIC SHOCK BE SURE TO:

- Never plug the mirror into the wall socket until fully assembled.
- Never hang or drape clothes or any other materials over the mirror and/or bulbs.
- Avoid placing objects against or close to the bulbs.
- Never expose the mirror to direct sunlight. Reflected light can cause fire.
- Keep cord and bulbs away from heated surfaces.
- Never place mirror where small children can reach it. It is not a toy.
- Never operate this mirror if it has a damaged cord or plug, if it is not working properly, if it has been dropped or otherwise damaged or submerged in water, return unit to manufacturer for examination.
- Never drop or insert and object into the opening of the mirror.

## CLEANING AND MAINTENANCE GUIDE

- Always unplug the mirror before cleaning.
- Do not immerse the mirror in water or any other liquid when cleaning.
- Do not use harsh or abrasive cleaning products on any surface of the mirror.
- Clean the mirror with a slightly damp clean soft cloth and buff with a dry soft cloth.
- Hardware may loosen over time. Periodically check to make sure all connections are tight. Re-tighten if necessary.
- Keep the mirror away from long periods in direct sunlight as reflected sunlight and additional heat can cause fire.
- Place in a cool, dry area out of the reach of children, where it will not be damaged.
- Handle the power cord carefully for longer life. Do not jerk or strain at the plug connections or wrap the cord around the mirror for storage - this could cause the cord to become damaged and short circuit. To store the mirror, coil the cord loosely starting at the appliance end and place cord next to the mirror to secure it.