

## Rimini 500.40.14 - 500.40.16 INSTALLATION INSTRUCTIONS



Please read these instructions carefully before installation.  
Installation should be carried out by a qualified electrician.

### GENERAL

- THIS PRODUCT CONFORMS TO UK SAFETY STANDARDS AND MUST BE INSTALLED IN ACCORDANCE WITH CURRENT IEE WIRING REGULATIONS AND BUILDING REGULATIONS (PART P). THIS PRODUCT MUST BE EARTHED, AND SHOULD NOT BE CONNECTED TO AN UNEARTHED CIRCUIT.
- IF THERE ARE ONLY TWO WIRES COMING FROM YOUR POWER SUPPLY IT MEANS THAT THIS FITTING CAN BE WIRED TO AN UNEARTHED CIRCUIT.
- ENSURE THAT CONNECTIONS ARE TURNED OFF AT THE CONSUMER UNIT OR FUSE BOARD BEFORE INSTALLING OR CARRYING OUT ANY MAINTENANCE.
- THIS PRODUCT IS FOR IN DOOR USE ONLY.
- THIS PRODUCT IS IP44 RATED AND CAN BE INSTALLED IN BATHROOM ZONE 2 (AS DEFINED BY THE IEE WIRING REGULATIONS) AND BEYOND. SEE BATHROOM DIAGRAM BELOW.
- REPLACE FAILED LAMPS IMMEDIATELY. ALLOW THE GLASS, LAMP AND FITTING TO COOL BEFORE REPLACING THE LAMP.

### IEE Bathroom Zones Diagram

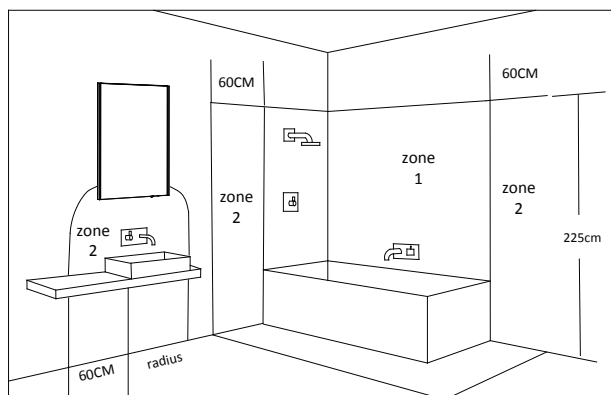

### OUTSIDE ZONES

### IMPORTANT

- When working at heights, please use a suitable platform to work from.
- Please note: For new installations, check for any electrical cables or pipe work (gas/water) in the vicinity of the intended mounting point before proceeding with the installation.
- Ensure that the fixing location is able to take the weight of the complete fitting. Wear suitable eye protection when drilling. Be careful when using power tools near water.

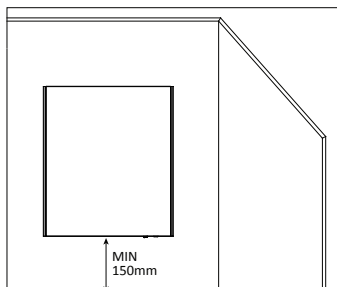

- The product must be installed with a minimum distance of 150mm between the infrared sensor and an adjacent countertop or obstruction to ensure correct function of the sensor (see diagram left)

Do NOT strike mirror glass with hard or pointed items. It is recommended that the product is cleaned with a soft, dry, non abrasive cloth. Do NOT use cleaning agents or abrasive materials on any type of finished surface. Do NOT allow moisture to come into contact with the electrical components.

### Compliance

This product complies with the following safety standards:  
BS EN 60598-1: 2008+A11: 2009, EN60598-2-1: 1989

### Wiring

This product is manufactured to class I category and requires an earth connection

### COLOUR CODING:

- L - Live = Brown
- Neutral = Blue

⊕ - Earth = Green & Yellow

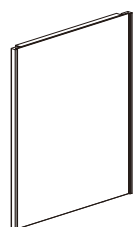

Rimini 500.40.14

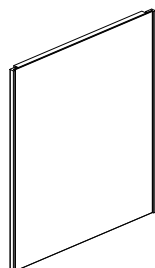

Rimini 500.40.15

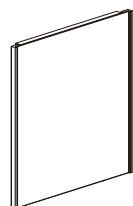

Rimini 500.40.16

## Rimini 500.40.14 - 500.40.16 INSTALLATION INSTRUCTIONS



### Installation procedure

1. Open the carton and make sure all the parts listed below are present

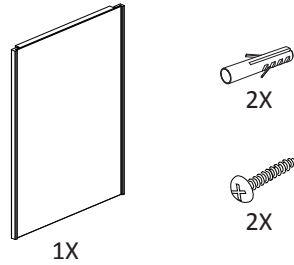

2. Mark a desired height of the mirror. Drill the required holes and insert the wall plugs.  
Note: Wall plugs supplied are only suitable for solid stone/brick walls. Please ensure the screws are fully tight. The mirror can be mounted either portrait or landscape.

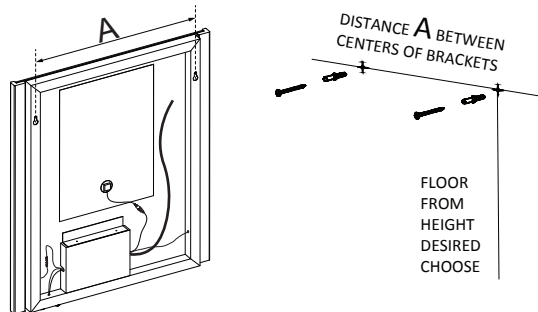

3. Make the electrical connections ensuring first that the electrical supply has been turned off. This mirror is a class 1 product and requires an earth connection. It should be installed in accordance with the latest IEE regulations.

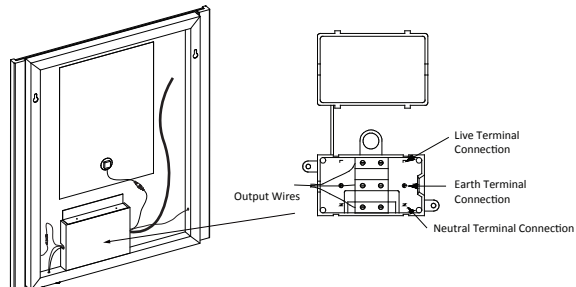

4. Hang the mirror onto the wall.

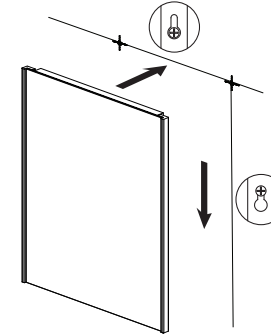

Waste Electrical & Electronic Equipment Regulations (WEEE) requires that any of our products showing this mark (left) must not be disposed of with other household or commercial waste. Pebble Grey Ltd does not levy any WEEE disposal charges to its customers for affected WEEE related products. To prevent possible harm to the environment or human health from uncontrolled waste disposal, please separate any such product from other waste types and recycle it responsibly at your local facilities. Check with your Local Authority, Recycling Center or retailer for recycling advice.

### GUARANTEE

This product has a free replacement parts guaranteed in the UK for a period of 5 year from the date of purchase. The guarantee is invalid in the case of improper use, incorrect installation or tampering.

Should this product fail during the guarantee period, please contact our support team by email at [support@pebblegrey.co.uk](mailto:support@pebblegrey.co.uk) and we will replace the relevant component part free of charge.

Pebble Grey does not accept responsibility for any installation costs associated with the replacement of the component parts. Your statutory rights are not affected. Pebble Grey Ltd reserve the right to alter specifications without prior notice.